

Inotherm

Inotherm aluminium doors are the crème de la crème of entrances and one of the most sought-after range of doors in Europe.

EXCLUSIV Aluminium Entrance Doors

1 Above-standard profile thicknesses

Due to their above-standard thickness, all entrance doors provide you with outstanding thermal insulation and high energy savings.

2 Anti-bending expansion layer

For better statics, an expansion layer is added to all entrance doors, which prevents the bending or deformation of the entrance door and maintains the stability of the door even with large temperature swings.

3 Additional seals

Our doors are sealed with three round liquid seals with vulcanised corner joints for better thermal insulation.

4 Thermal bridge interruption

A special heat barrier in the gap between the panel and the frame prevents heat from escaping and reduces your heating costs.

5 Aluminium threshold

A robust aluminium threshold with a thermal break reduces the energy flow in the lower part of the door and allows for the invisible mounting of the door frame.

Triple Glazing

All entrance doors feature glazing with three 6mm thick glass panes, which additionally insulate and enhance the safety of your home.

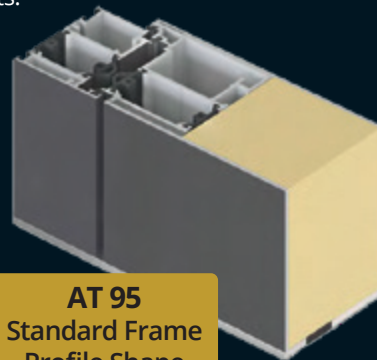

AT 95
Standard Frame
Profile Shape



Inotherm Features:

- ✓ "Design Your Own Door" feature available
- ✓ Single doors up to 1260mm wide x 2700mm high
- ✓ Schuco patented profile
- ✓ 0.7W/m²k - 0.9W/m²k 'U' value range
- ✓ 0.5W/m²k when in combination with motif and ornamental glass
- ✓ 3mm thick aluminium exterior and interior skins
- ✓ Triple glazed as standard
- ✓ 5/6 point locking as standard
- ✓ Modern and Traditional styles

Optional Extras



Finger print recognition

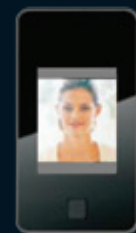

Electronic Peep-hole



InoSmart Security System

Inotherm

Choose from over 200 ultra modern or traditional designs

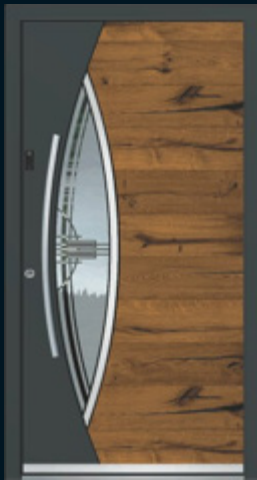

AE 1046



AAE 1712

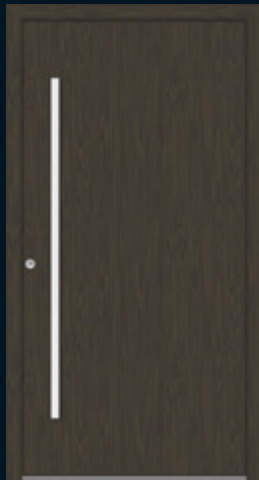

AGE 1030

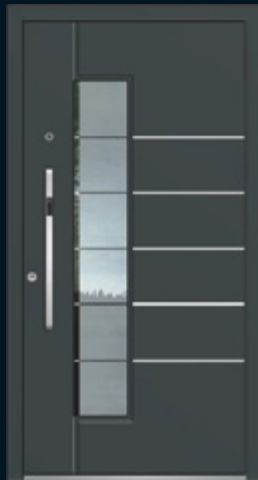

AGE 1130



AGE 1527

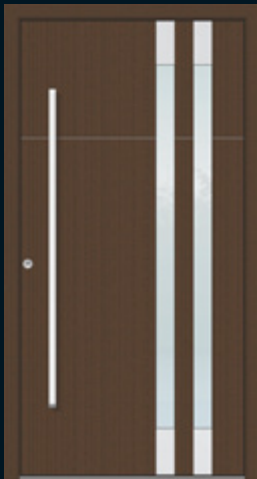

AGE 1654

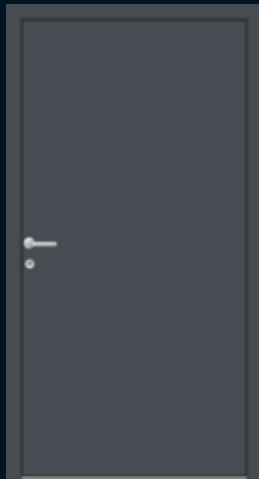

AK 402

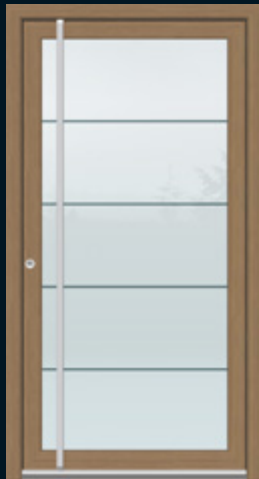

ASS 1700



ATE 1451



AEE 1283

A wide range in excess of 80 Colours and Finishes

From Standard to Matt, Metallic, Wood and Patterned



- Traffic
White Matt
- Anthraxite
Grey Matt
- Aluminium
Grey Fine
Structure
- Dark
Brown Fine
Structure
- Anthraxite Grey
Fine Structure
- Eisenglimmer
Fine Structure
- Grey Sprengel
Fine Structure
- Split Oak
light
- Split Oak
Dark
- Walnut
- Golden Oak
- Golden Oak
Deeper Grain
- Mountain
Pine
- Rust



Hinge Colours

Gold, Black and Silver

Threshold Colours

Anodised Black, Silver and Anodised Gold



Why not consider the other collections available from *The Choices brand*

Windows, Doors, Conservatories & Orangeries manufactured from state of the art

PVCU and Aluminium for Domestic and Commercial properties.

Windows and Doors